

Tag-it HF-I Pro Transponder IC

Reference Guide

11-09-21-065 November 2005



Edition One – November 2005

This is the first edition of this reference guide. It contains a description of the Tag-it HF-I Pro Transponder IC, the specifications, dimensions and instructions for further handling.

Important Notice

Texas Instruments (TI) reserves the right to make changes to its products or services or to discontinue any product or service at any time without notice. TI provides customer assistance in various technical areas, but does not have full access to data concerning the use and applications of customer's products.

Therefore, TI assumes no liability and is not responsible for customer applications or product or software design or performance relating to systems or applications incorporating TI products. In addition, TI assumes no liability and is not responsible for infringement of patents and/or any other intellectual or industrial property rights of third parties, which may result from assistance provided by TI.

TI products are not designed, intended, authorized or warranted to be suitable for life support applications or any other life critical applications which could involve potential risk of death, personal injury or severe property or environmental damage.

The **TIRIS** and **TI-RFID** logos, and the words **TIRIS**, **TI-RFID** and **Tag-it** are trademarks or registered trademarks of Texas Instruments Incorporated.

Copyright © 2005 Texas Instruments Incorporated (TI)

This document may be downloaded onto a computer, stored and duplicated as necessary to support the use of the related TI product. Any other type of duplication, circulation or storage on data carriers in any manner not authorized by TI represents a violation of the applicable copyright laws and shall be prosecuted.

Read This First

About This Guide

This reference guide for the Tag-it HF-I Pro Transponder IC is designed for use by TI partners who are engineers experienced with Radio Frequency Identification Devices (RFID) and the processing of wafers.

Regulatory, safety and warranty notices that must be followed are given in Chapter 4.

Conventions



WARNING:

A WARNING IS USED WHERE CARE MUST BE TAKEN OR A CERTAIN PROCEDURE MUST BE FOLLOWED, IN ORDER TO PREVENT INJURY OR HARM TO YOUR HEALTH.



CAUTION:

This indicates information on conditions which must be met, or a procedure which must be followed, which if not heeded could cause permanent damage to the equipment or software.



Note:

Indicates conditions which must be met, or procedures which must be followed, to ensure proper functioning of the equipment or software.



Information:

Indicates information which makes usage of the equipment or software easier.

If You Need Assistance

For more information, please contact the sales office or distributor nearest you. This contact information can be found on our web site at:

<http://www.ti-rfid.com>.

Document Overview

Preface: Read This First	3
Chapter 1: Product Description	6
1.1 General.....	7
1.2 System Description.....	8
1.3 Product Description	8
1.4 Functional Description.....	9
1.5 Memory Organization	10
1.6 Command Set.....	11
1.7 Ordering Information and Part Numbers	12
Chapter 2: Specification	13
2.1 Electrical Specification	14
2.3 Mechanical Wafer Specification	15
2.4 Mechanical Die Specification	17
2.4 Bump Specification.....	19
Chapter 3: Shipping, Packing and further Handling.....	20
3.1 Lot Definition.....	21
3.2 Wafer identification	21
3.3 Wafer Map File	23
3.4 Ink Dot Specification.....	24
3.5 Packing for Wafers	25
3.6 Packing for sawn Wafers.....	26
3.7 Barcode Label	27
3.8 Storage Conditions	27
3.9 Antenna Calculation	28
Chapter 4: Regulatory, Safety and Warranty Notices.....	30
4.1 Regulatory, Safety and Warranty Notices	31
4.2 Warranty and Liability	31
4.3 Hazards from Electrostatic Discharge ESD	32
APPENDIX A: Terms & Abbreviations	33

List of Figures

Figure 1 RFID System with reader, antenna and Tag-it HF-I Transponder	8
Figure 2 Memory organization of the Tag-it HF-I Pro Transponder IC.....	10
Figure 3 Wafer on FFC.....	16
Figure 4 Antenna and Test Pad Location.....	18
Figure 5 Cross section of Bump.....	19
Figure 6 Position of Waferidentification Code.....	21
Figure 7 Waferidentification Code 1.....	22
Figure 8 Waferidentification Code 2.....	22
Figure 9 Ink Dot Drawing.....	24
Figure 10 Packing of Wafers.....	25
Figure 11 Packing of sawn Wafers.....	26
Figure 12 Barcode Label.....	27
Figure 13 Recommended operating range - Impedance vs Antenna Q.....	29

List of Tables

Table 1 Command Set for Tag-it HF-I Pro Transponder IC.....	11
Table 2 Part Numbers.....	12
Table 3 Absolute Maximum Ratings.....	14
Table 4 Recommended Operating Conditions.....	14
Table 5 Electrical Characteristics.....	15
Table 6 General Mechanical Wafer Specification.....	15
Table 7 Mechanical Wafer Specification after Grinding, Sawing on FFC.....	16
Table 8 Mechanical Die Specification.....	17
Table 9 Antenna and Test Pad Location.....	17
Table 10 Bump Specification.....	19
Table 11 Ink Dot Specification.....	24
Table 12 Ink Dot Placement.....	24
Table 13 Storage Conditions.....	27
Table 14 Antenna system parameters.....	29

Introduction

This chapter introduces you to the Tag-it HF-I Pro Transponder IC.

Topic	Page
--------------	-------------

1.1 General.....	7
1.2 System Description.....	8
1.3 Product Description	8
1.4 Functional Description	9
1.5 Memory Organization	10
1.6 Command Set.....	11
1.7 Ordering Information and Part Numbers	12

1.1 General

The **Tag-it HF-I Pro** Transponder IC is part of TI's 13.56MHz product family which is based on the ISO/IEC 15693 standard for contactless integrated circuit cards (vicinity cards) and ISO/IEC 18000-3 standard for item management. The **Tag-it HF-I Pro** Transponder IC builds the basis for various available inlay shapes which are used as consumable smart labels in markets requiring quick and accurate identification of items, such as:

- asset tagging
- electronic ticketing
- anti-counterfeit prevention
- building access badges

User data is written to and read from memory blocks using a non-volatile EEPROM silicon technology. Each block is separately programmable by the user and can be locked to protect data from modification. Once the data has been 'locked' it can only be changed by the password protected write command.

Multiple transponders, which appear in the Readers RF field, can be identified, read from and written to by using the **Unique Identifier (UID)**, which is programmed and locked at the factory and can not be changed.

1.2 System Description

For operation a reader with antenna is required to send a command to the transponder and to receive its response (see figure 1). The command of the Reader can be either in addressed or non-addressed mode. The Transponder does not transmit data until the reader sends a request (Reader talks first principle).

Figure 1 RFID System with reader, antenna and Tag-it HF-I Transponder

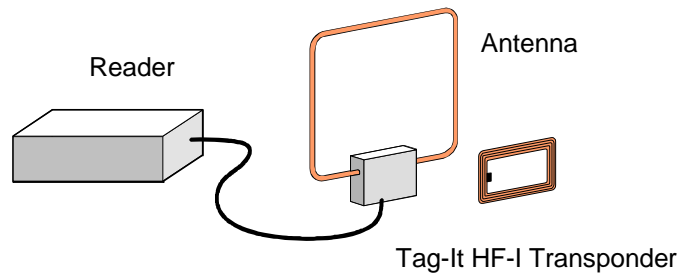

1.3 Product Description

The Tag-it HF-I Pro Transponder IC is compliant to the ISO/IEC 15693 and ISO/IEC 18000-3 standard. To build a complete transponder, the Tag-it HF-I Pro Transponder IC has to build a resonance circuit with the antenna it is assembled on e.g. an etched aluminium antenna

1.4 Functional Description

The Tag-it HF-I Pro Transponder IC is a low power, full duplex Transponder IC for use with passive contactless identification transponder systems.

The transponder IC is designed to operate with a 13.56MHz carrier frequency. The ISO standard defines for some communication parameters several modes in order to meet different international radio regulations and different application requirements. Therefore communication between the reader and the transponder (Down-Link communication) takes place using ASK modulation index between 10% and 30% or 100% and datacoding (pulse position modulation) '1 out of 4' or '1 out of 256'.

According to ISO 15693 Up-Link communication (Transponder to Reader) can be accomplished with one subcarrier (ASK modulation) or with two subcarrier (FSK modulation). Both modes (ASK and FSK) can operate with either high or low data rate. **The transponder will answer in the mode it was interrogated from the reader and supports all communication parameter combinations.**

Up- and Down-Link are frame synchronized and CRC check sum secured.

Each Tag-it HF-I Pro Transponder IC has a 'unique' address (UID) stored in two blocks which are factory-programmed and 64 bits long ($=2^{64}$ different addresses). This can be used for addressing each transponder uniquely and individually for a one-to-one exchange between the reader and the transponder. A mechanism to resolve collisions of a multiplicity of transponders (Anticollision) is also implemented. This special feature allows multiple transponders to be read simultaneously and offers the capability to inventory in a very short time a large number of transponders by their unique address, provided they are within the reader operating range.

Also, the **Application Family Identifier (AFI)** which is optional in the ISO15693 is supported by the Tag-it HF-I Pro Transponder.

For more details about the communication between reader and transponder see ISO/IEC 15693 and the Tag-it HF-I Pro Extended Command Specification.

1.5 Memory Organization

User data is read and stored in a 256Bit non-volatile user memory that is organized in 8 blocks. Each block with 32 bit is user programmable and can be locked individually to protect data from modification. Once set, the lock bit cannot be reset. The user memory is field programmable per block. Two levels of block locking are supported: Individual block locking by the user (U) or individual block locking of factory programmed data (F) during manufacturing. Bit 2 of the “Block Security Status” Byte defined in ISO 15693-3 is used to store the Factory Lock Status of the Block. Factory Block locking irreversibly protects the locked data from any further reprogramming. User locked blocks can be reprogrammed by use of the password protected write command.

Figure 2 Memory organization of the Tag-it HF-I Pro Transponder IC

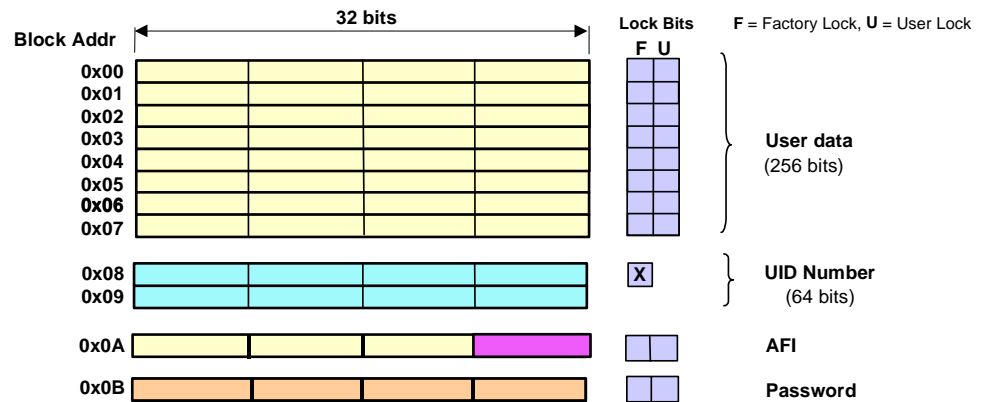

1.6 Command Set

Table 1 Command Set for Tag-it HF-I Pro Transponder IC

Request	Request Code	Request Mode				
		Inventory	Addressed	Non-Addressed	AFI	Opt. Flag
ISO 15693 Mandatory and Optional Commands						
Inventory	0x01	✓	-	-	✓	0/-
Stay Quiet	0x02	-	✓	-	-	0/-
Read_Single_Block	0x20	-	✓	✓	-	-/1
Write_Single_Block	0x21	-	✓	✓	-	-/1
Lock_Block	0x22	-	✓	✓	-	-/1
TI Custom Commands						
Kill	0xA4	-	✓	-	-	-/1
WriteSingleBlockPwd	0xA5	-	✓	-	-	-/1

✓: Implemented
 -: Not applicable
 0/1: Option Flag needed



Note:

The Option Flag (Bit 7) of the ISO 15693 defined Request Flags must be set to 1 for all Write and Lock commands to respond properly.

For reliable programming we recommend a programming time \geq 10ms before the reader sends the End Of Frame (EOF) to request the response from the Transponder.

1.7 Ordering Information and Part Numbers

The Tag-it HF-I Pro Transponder IC is available with following finishing options:

Table 2 Part Numbers

Part-number	Bumping	Inking	Grinding	Sawing
RF-HDT-SJMS-G1	Yes	Yes	Yes	Yes



Note: Other Finishing Options on request

Specification

This chapter provides the electrical and mechanical specifications of the Tag-it HF-I Pro Transponder IC.

Topic	Page
--------------	-------------

2.1 Electrical Specification	14
2.3 Mechanical Wafer Specification	15
2.4 Mechanical Die Specification	17
2.4 Bump Specification.....	19

2.1 Electrical Specification

Table 3 Absolute Maximum Ratings

Parameter	Symbol	Note	Min	Nom	Max	Unit
Antenna Input Current	Iant_dc				10	mA
Antenna Input Voltage	Vant_dc				10	V
Storage Temperature	Ts		-40		125	°C
Junction (Chip) Temp.	Tj				150	°C
ESD Immunity	ANT1, ANT2 TDAT, GND	HBM	2.5 2.0			kV



Note:

Stress beyond the limits of those listed under 'Absolute Maximum Ratings' may cause permanent damage to the device. Functional operation of the device under these or any other conditions beyond those indicated under 'Recommended Operating Conditions' is not implied. Exposure to absolute-maximum-rated conditions for extended time may affect device reliability

Table 4 Recommended Operating Conditions

Parameter	Symbol	Note	Min	Nom	Max	Unit
Operating Temperature	TA		-40		+85	°C
Carrier Frequency	fTX			13.56		MHz
Antenna Input Voltage	VANT	@ fTX unmodulated	2.5		Vlim	V
Impedance of LC circuit	Z		6.5		15.5	kOhm

Table 5 Electrical Characteristics

Parameter	Symbol	Note	Min	Nom	Max	Unit
Input Capacitance	C _{IN}	@ 2V _{RMS}	-10%	23.5	+10%	pF
Operating Supply Current	ICC	VANT=min			25	uA
Operating Supply Current	ICC	Programming			35	uA
Uplink Modulation Index	M _{PICC}	VANT<7V	0.1		0.3	
Limiter Clamping Volt.	V _{lim}				10	V
Data Retention	t _{DRET}	55°C	10			Years
Write & Erase Endurance	W&E	T _a =25°C	100 000			Cycles

Note:



For highest possible read-out coverage we recommend to operate readers at a modulation depth of 20% or higher.

2.3 Mechanical Wafer Specification

Table 6 General Mechanical Wafer Specification

Parameter	Value
Wafer diameter	200mm +/-0.3mm (8 inch)
Thickness	711um
Scribe line width	84µm
Electrical connection of substrate	VSS potential
Complete dies per wafer	24172

Table 7 Mechanical Wafer Specification after Grinding, Sawing on FFC

Parameter	Value
Backside Material	Si
Roughness:	
Ra	500 Ångstrom
Rtm	2500 Ångstrom
Thickness	150 ± 13µm

Figure 3 Wafer on FFC

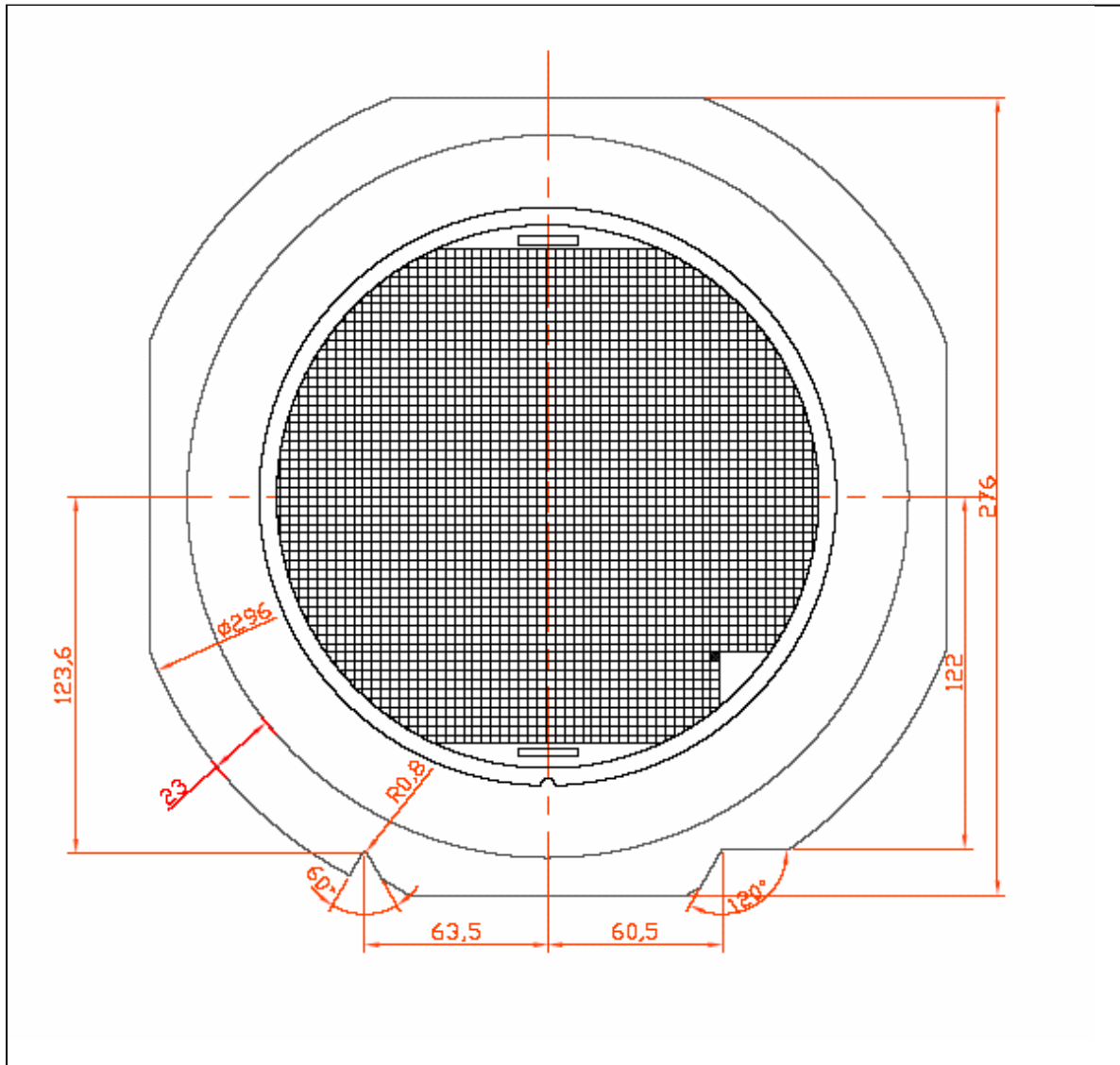

2.4 Mechanical Die Specification

Table 8 Mechanical Die Specification

Parameter	Value
Bond pad metallization material	ALCu0.5 %
Bond pad metallization thickness	0.95 μ m
Bond & Test Pad location	Table 9
Die dimension (including scribe line)	1080 * 1080 μ m +/- 15 μ m
Die dimension (excluding scribeline)	996 * 996 μ m +/-15 μ m
Top side passivation material	SiNi
Passivation thickness	1.1 μ m

Table 9 Antenna and Test Pad Location

Pad No	Name	LLCx[μ m]	LLCy[μ m]	URCx[μ m]	URCy[μ m]
1	ANT1	30	30	n.a.	n.a.
2	ANT2	n.a.	n.a.	966	966
Test pad					
3	TDAT	118	866	168	936
4	GND	836	60	886	130

Figure 4 Antenna and Test Pad Location

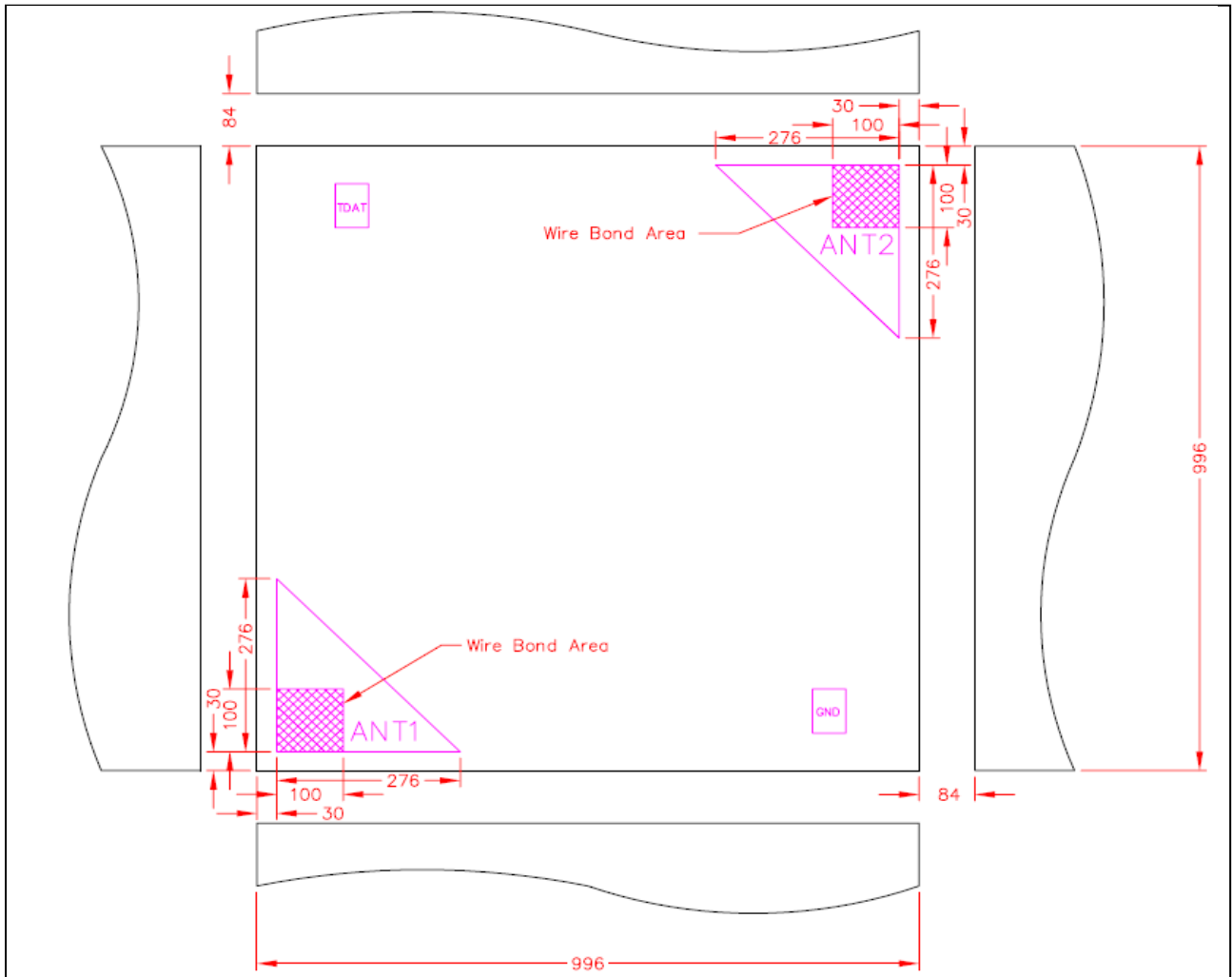

2.4 Bump Specification

Table 10 Bump Specification

Parameter	Value
Bump material	NI covered with AU, chemical process
Bump height	25 μ m +/- 10%
Bump hardness	>HV 450
Surface roughness	<1 μ m
Shear strength	>150cN
Contact resistance between bump and AL-Substrate	<25mOhm



Note:

Test pads are not bumped. Contact between the test pads and the antenna is not allowed as it can have an impact on the electrical performance of the transponder.

Figure 5 Cross section of Bump

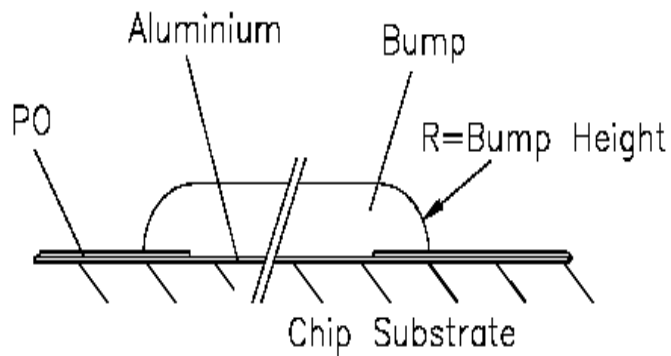

Shipping, Packing & further Handling

Topic **Page**

3.1 Lot Definition.....	21
3.2 Wafer identification.....	21
3.3 Wafer Map File	23
3.4 Ink Dot Specification.....	24
3.5 Packing for Wafers	25
3.6 Packing for sawn Wafers.....	26
3.7 Barcode Label	27
3.8 Storage Conditions.....	27
3.9 Antenna Calculation	28

3.1 Lot Definition

A definite quantity of wafers from the same diffusion batch produced under presumed uniform conditions. Occasionally a lot equals 25 wafers.

3.2 Wafer identification

Each wafer is marked with laser marking to identify the wafer. The wafermap file is linked to the wafer id. There are 2 marks on the wafer.

The following figure shows the position of the wafer identification codes. The reference die is the black marked die in the corner at the right lower position of the wafer.

Figure 6 Position of Waferidentification Code

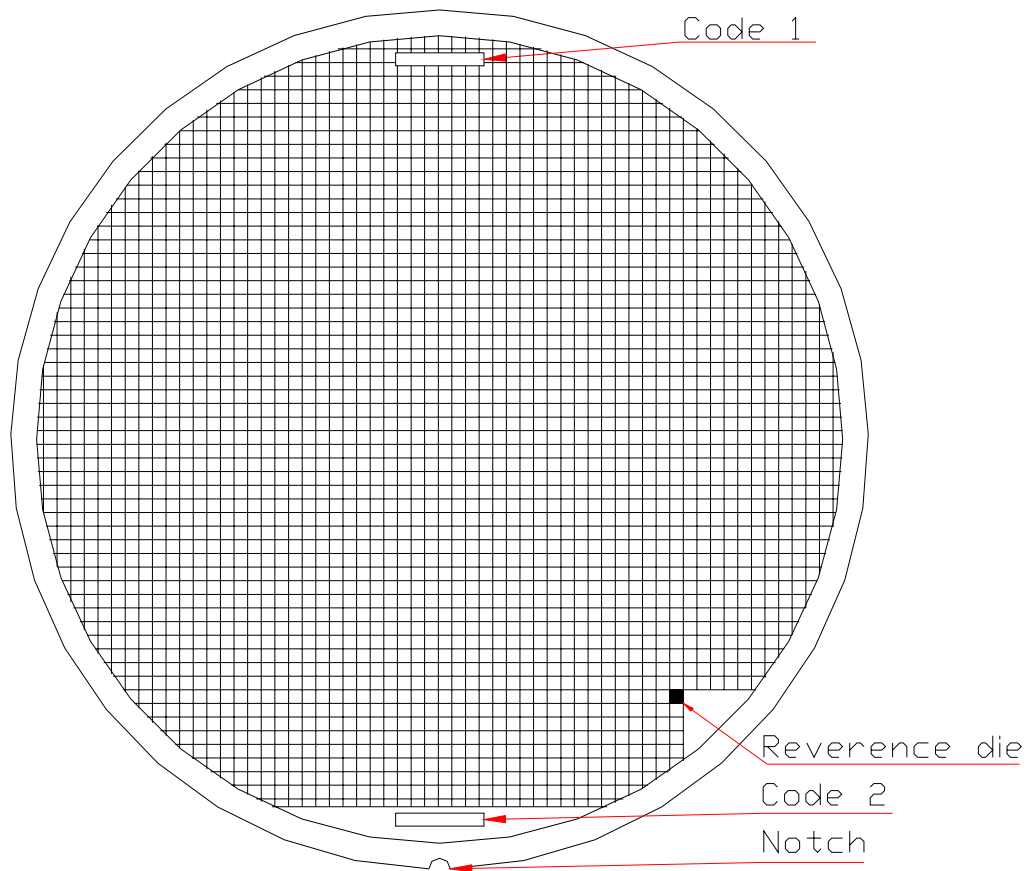

Code 1: Wafer Lot number naming rule:

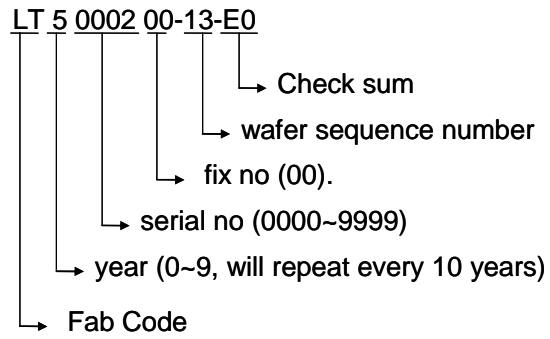

Figure 7 Waferidentification Code 1



Code 2: Wafer Lot number naming rule:

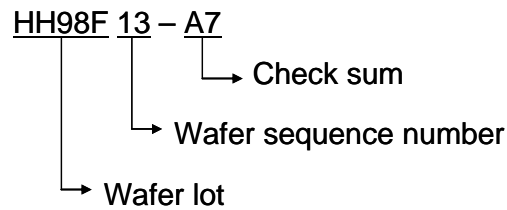

Figure 8 Waferidentification Code 2



3.3 Wafer Map File

All lots are supplied with wafer mapping file. This mapping file is stored on a CD and enclosed in the pack box.

The mapping file is stored for 3 years, if any problem might occur. We handle our TI world wide wafer map standard. The wafer file name is explained as follows:

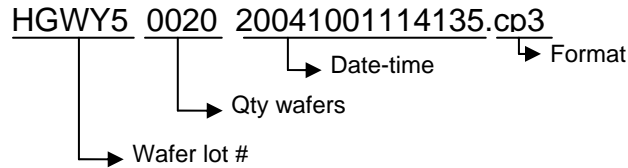

The standard TI worldwide wafermap file is .cp3, this is an ASCII format. The most important facts are sorted out in a list like the below example shows. The lot definition can be found also in this list. Also the tested dies and pass dies are shown.

```

CUSTOMER ID      : TIG
FAB ID          : FAB8E
PRODUCT ID       : W37112B3
CUST PRODUCT ID : W37112B3
FAB PRODUCT ID  : H3337F-NZWN
LOT ID          : HGWY5.00
CUST LOT ID     :
FAB LOT ID      : N47HGWY5.00
WAFER ID        : 20
FLOW ID         : CP3
PRODUCT VERSION : 6
START TIME      : 2004/10/01 11:41:35
STOP TIME       : 2004/10/01 11:53:41
SUBCON          : UMC01
TESTER NAME     : J750#76
TEST PROGRAM    : TMS37112BP3C1
LOAD BOARD ID   :
PROBE CARD ID   : JATCYH03
SITE NUM        :
DUT ID          :
DUT DIFF NUM    :
OPERATOR ID     : 8341
GROSS DIE       : 16268
TESTED DIE      : 16268
PASS DIE        : 15723
YIELD           : 96.65%
PROBING NOTCH   : DOWN
MAP NOTCH       : DOWN
MAP ROW         : 154
MAP COLUMN      : 137
MAP BIN LENGTH  : 2
SHIP            : YES
  
```

3.4 Ink Dot Specification

All Tag-it HF-I Pro Transponder ICs are electrically tested and dies which fail the probetest will be inked. Bump failures are not marked with an ink dot.

Table 11 Ink Dot Specification

Parameter	Value
Diameter	Min 400 μm
	Max 700 μm
Height	Max 25 μm
Colour	Black
Position	Central, not on bond pads

Figure 9 Ink Dot Drawing

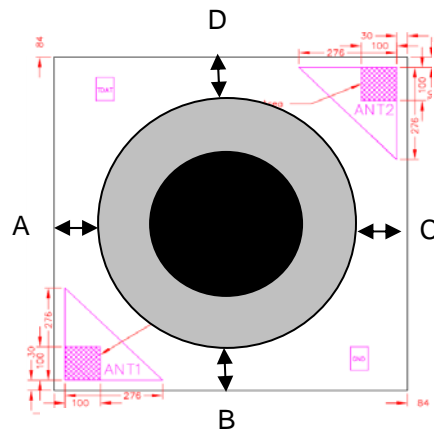

Table 12 Ink Dot Placement

No.	Max	Min	Remark
A	550	200	
B	400	200	
C	550	200	
D	400	150	
Ink	700	400	Size limit

3.5 Packing for Wafers

The wafers are packed for transportation to protect them against shock, static discharge and contamination in a wafer shipper box up to 25 wafers. This box is packed in an antistatic moisture bag with silica gel and in a double layered carton box.



Note:

When the silica gel has changed the color to blue it is an indication that moisture has entered the bag.

Figure 10 Packing of Wafers

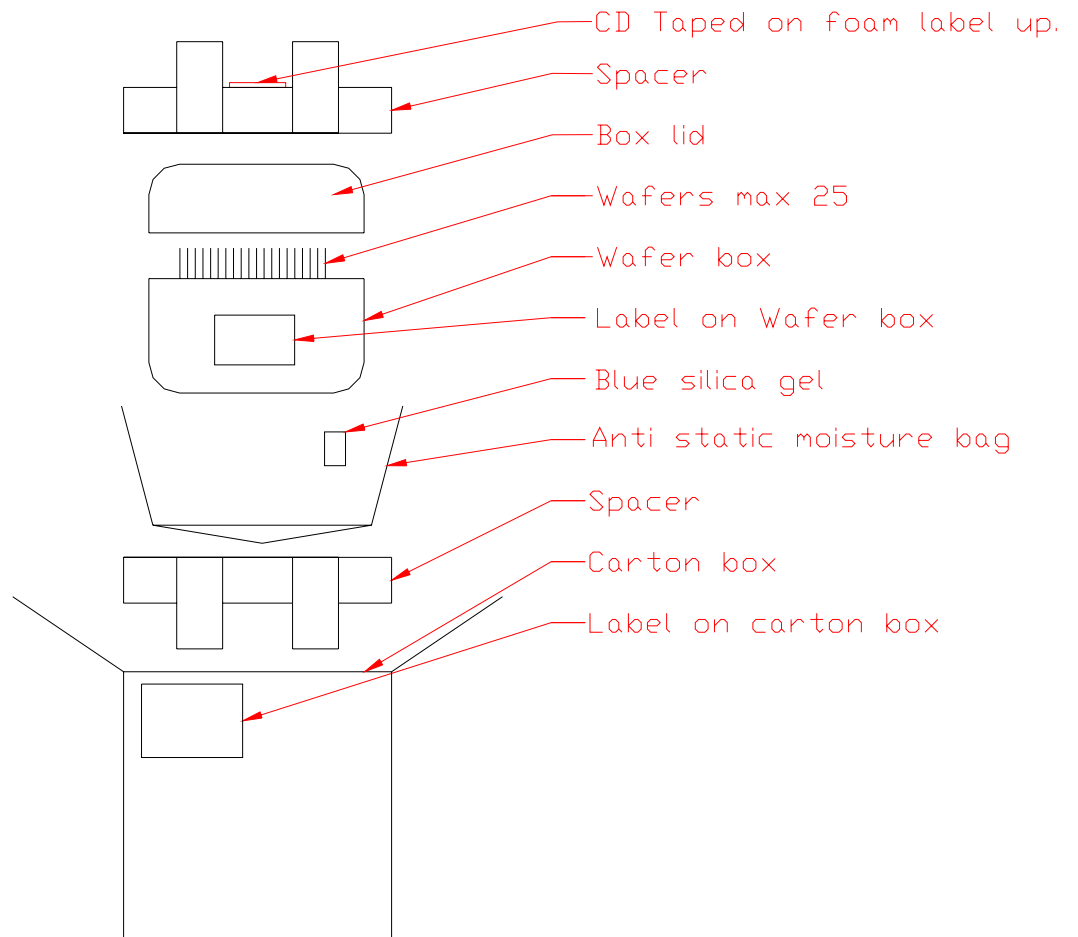

3.6 Packing for sawn Wafers

Sawn wafers are mounted on foil and delivered on standard 8" disco wafer frame (see Figure 3 Wafer on FCC). A special plastic container is used to store up to 25 wafers in frames. This plastic container is packed in an antistatic moisture bag with silica gel and in a double layered carton box.



Note:

When the silica gel has changed the color to blue it is an indication that moisture has entered the bag.

Figure 11 Packing of sawn Wafers

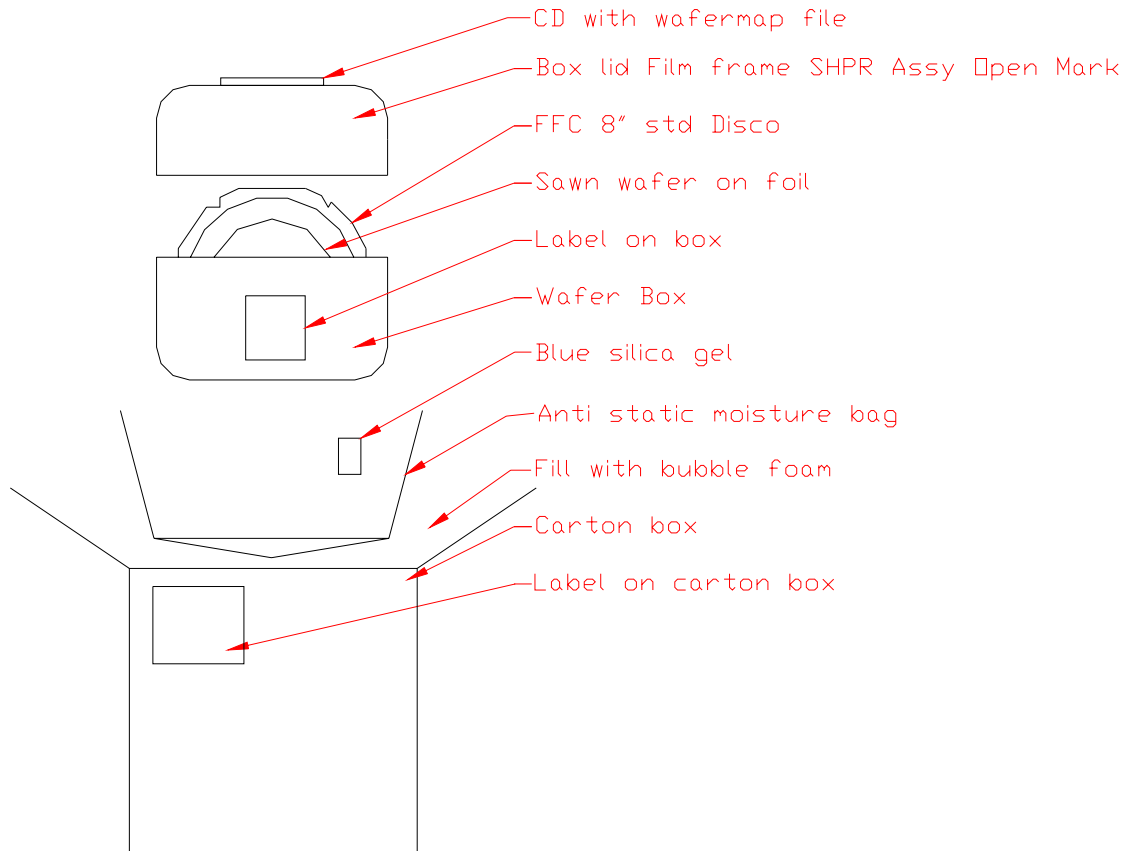

3.7 Barcode Label

The following figure shows the Barcode Label that is placed on the packing box, the wafer container and the CD with the Map File.



Note:

The data provided below is an example and should only be viewed as guide values.

Figure 12 Barcode Label

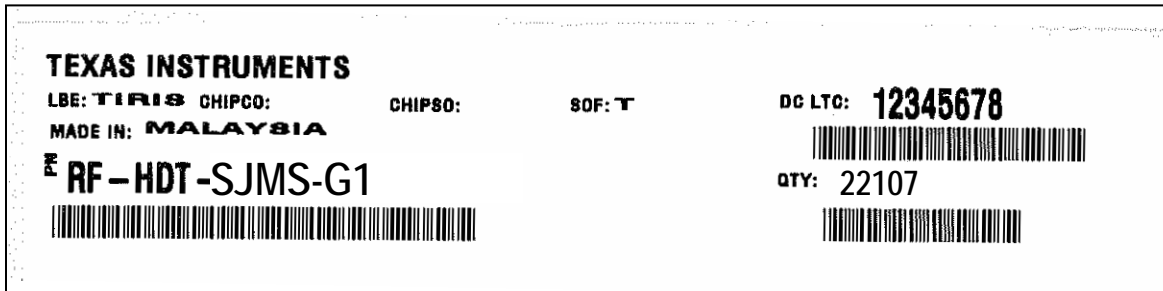

PN Part Number
 QTY Quantity of functional inlays per reel
 total quantity (incl. non-functional units) may exceed this number
 DC LTC Datecode; Lot Number

3.8 Storage Conditions

The wafers should be kept in the original packing during storage.

Table 13 Storage Conditions

Parameter	Value
Temperature	20°C ± 5°C
Atmosphere	dried N ₂ or dried air with 40%-60% r.h.
Duration	Max. 6 months

3.9 Antenna Calculation

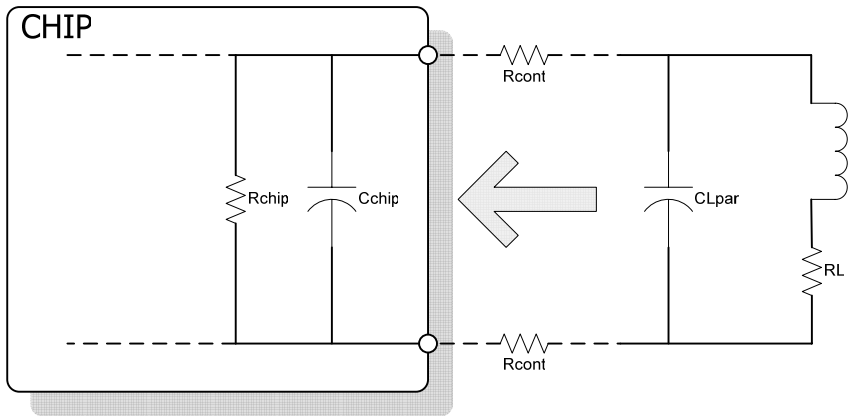

- Rchip: IC Input Impedance
- Cchip: IC Input Capacitance
- Rcont: Pad/assembly contact resistance
- CLpar: Parasitic capacitance of antenna
- RL: Series resistance of antenna
- L: Antenna Inductance

Resonance frequency:

$$f_{res} = \frac{1}{2 * \pi * \sqrt{L * C_{chip}}}$$

Total Quality factor:

$$Q_{res} = \frac{Q_c * Q_l}{Q_c + Q_l}$$

Input Impedance:

$$Z = Q_{res} * \sqrt{\frac{L}{C_{chip}}}$$

Based on an IC capacitance of 23.5 pF, the impedance shall be matched to be in the specified impedance range of 6.5 to 15.5kOhm to fit the IC capabilities.



Note:

If $Z > 15.5k\Omega$, reduced performance of read range must be considered.

Table 14 Antenna system parameters

Parameter	Min	Nom	Max	Tolerance [%]	Test conditions	Comment
Cchip [pf]	21.15	23.50	25.85	10	13.56MHz @ 2Vrms	
Qchip	80.00	100.00	120.00	20		
L [uH]	5.74	5.86	5.98	2	13.56MHz @ 2Vrms	
QL	15.00	40.00	44.00	10		
fres [MHz]	12.80	13.56	14.44			
Qres	12.63	28.57	32.20			
Z [kOhm]	6.58	14.27	15.48			

Figure 13 Recommended operating range - Impedance vs Antenna Q

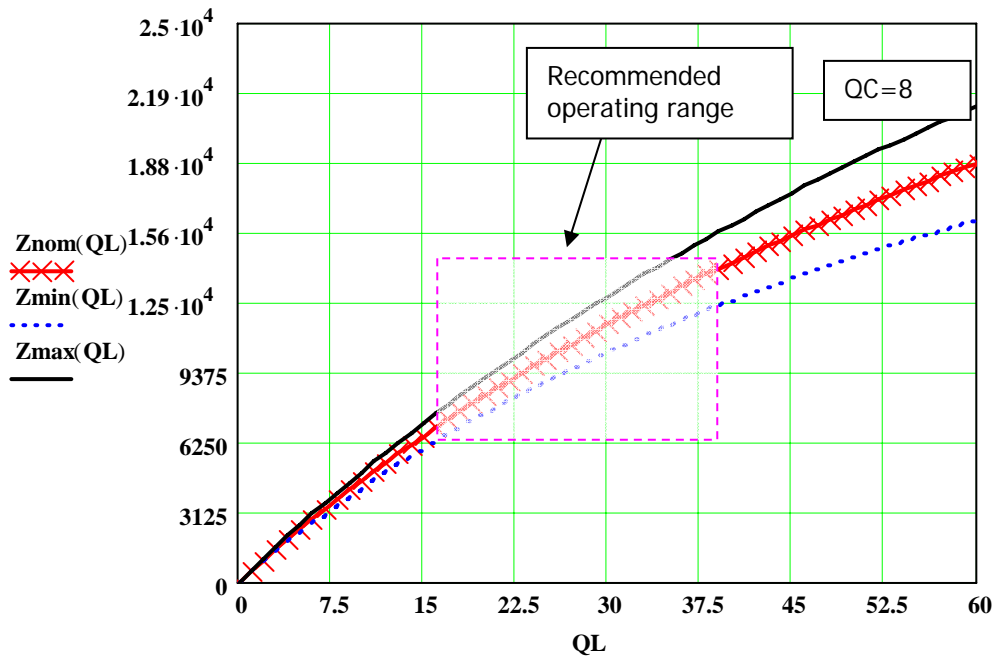

Regulatory, Safety and Warranty Notices

This chapter describes important safety precautions and safety regulations.

Topic	Page
4.1 Regulatory, Safety and Warranty Notices	31
4.2 Warranty and Liability	31
4.3 Hazards from Electrostatic Discharge ESD	32

4.1 Regulatory, Safety and Warranty Notices

An RFID system comprises an RF transmission device, and is therefore subject to national and international regulations.

A system reading from or writing to these transponders may be operated only under an experimental license or final approval issued by the relevant approval authority. Before any such device or system can be marketed, an equipment authorization must be obtained from the relevant approval authority.

The Tag-it HF-I Pro Transponder IC has been manufactured using state-of-the-art technology and in accordance with the recognized safety rules.

Observe precautions in operating instructions

- Condition for the safe processing, handling and fault-free operation of the Tag-it HF-I Pro Transponder IC is the knowledge of the basic safety regulations.
- All persons who operate with the Tag-it HF-I Pro Transponder IC must observe the guidelines and particularly the safety precautions outlined in this document.
- In addition, basic rules and regulations for accident prevention applicable to the operating site must also be considered.

4.2 Warranty and Liability

The "General Conditions of Sale and Delivery" of Texas Instruments Incorporated or a TI subsidiary apply. Warranty and liability claims for defect products, injuries to persons and property damages are void if they are the result of one or more of the following causes:

- improper use of the transponders IC
- unauthorized assembly, operation and maintenance of the transponders IC
- operation of the transponder IC with defective and/or non-functioning safety and protective equipment
- failure to observe the instructions given in this document during transport, storage, assembly, operation, maintenance and setting up of the transponder IC
- unauthorized changes to the transponder IC
- insufficient monitoring of the transponder ICs' operation or environmental conditions
- repairs
- catastrophes caused by foreign bodies and acts of God.

**CAUTION:**

Tag-it HF-I Pro Transponder ICs are 100% thoroughly tested. It is the responsibility of TI's customer to evaluate their assembly process for compatibility with the Tag-it HF-I Pro Transponder IC properties and to ensure through appropriate process controls that determined machine and material parameter are met on an ongoing basis. TI does not accept warranty claims for material that has already undergone packaging or conversion process.

4.3 Hazards from Electrostatic Discharge ESD

**WARNING:**

ELECTRONIC DEVICES CAN ALSO BE DESTROYED BY ELECTROSTATIC ENERGY.

Terms & Abbreviations

A list of the abbreviations and terms used in various TI-RFID manuals can now be found in a separate manual:

TI-RFID Product Manuals - Terms & Abbreviations

Document number 11-03-21-002